

EN

up+tec®



**Pedestal system**  
for raised floors

 **profilit+ec**  
positive profile



up+tec®





# up+tec®

Pedestals for raised floors with integrated system that allows the transition from self-levelling to fixed head positioning.



Patented system



# up+tec® FX

Fixed head pedestals for raised floors.



Patented system

# RAISED FLOORS

The installation of raised floors offers benefits that go beyond simple aesthetics. Piping, wiring and drains are located below the finished floor where all water management and other mechanical functions occur which allows for a uniform floor. Further, tile can be easily removed to allow access to these elements while providing high load capabilities. Profilitec's uptec system is the best solution for outdoor raised floors such as terraces, gardens, pool sides, verandas and public places.

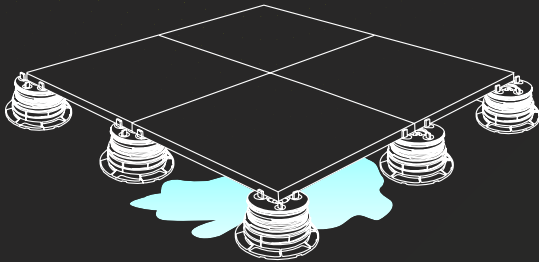

Efficient water management

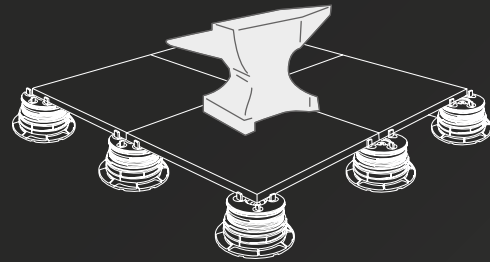

High load resistance

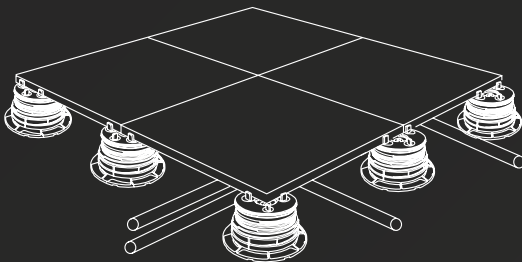

All mechanical elements hidden

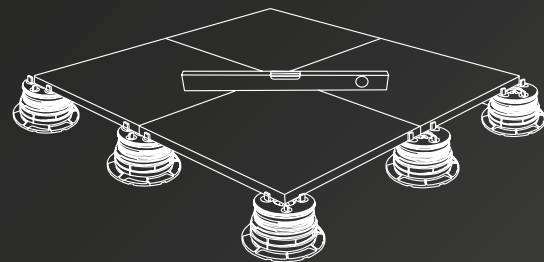

Completely level floor



# Applications

Terraces  
Poolsides  
Roof decks  
Walkways

Gazebo  
Hot tubs  
Gardens  
Bars and restaurants



# SELF-LEVELLING AND FIXED HEAD PEDESTALS

uptec

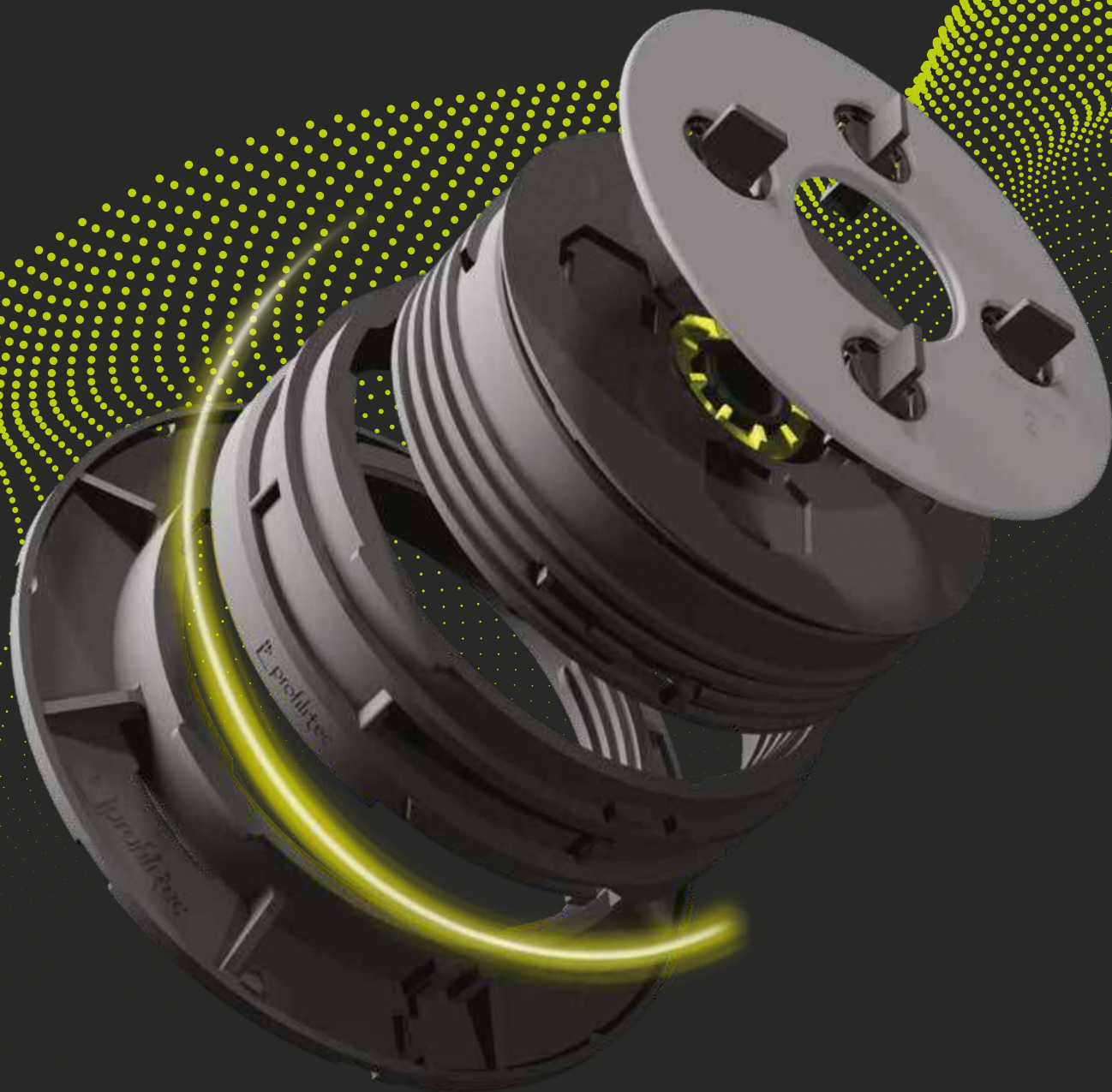



uptec<sup>®</sup> **3<sub>in</sub>1**

Uptec pedestals consist of self-leveling and fixed head supports that are adjustable in height. Based on the **3-in-1** concept, uptec includes 3 base items that minimize inventory levels. The uptec system can be assembled to any height and compensate for up to 5% slope of a structure's surface.

uptec<sup>®</sup>

uptec



**SUPAL**

Low pedestal



**SUPAS**

Standard pedestal



**SUPAR**

Modular ring

combinable with

**SUPA2**

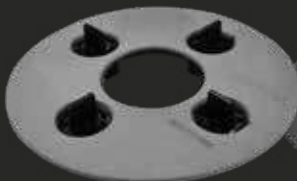

Head with 3/32"  
(2 mm) tabs

**SUPA4**

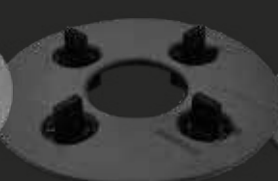

Head with 3/16"  
(4 mm) tabs

**SUPAW**

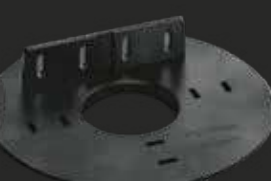

Head to be fixed on  
wooden joists

# COMPOSITION

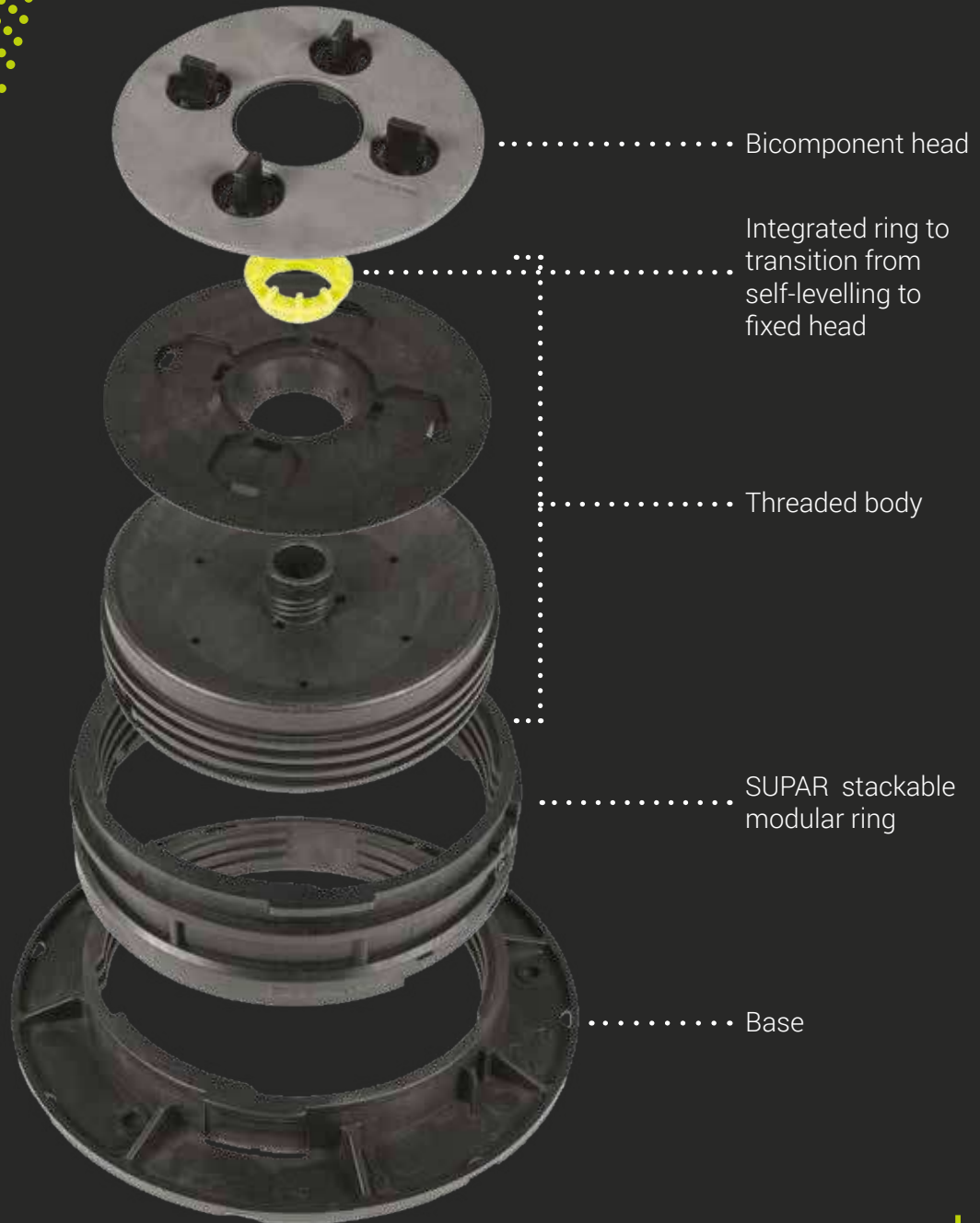

# HEIGHT PROGRESSION

The combination of the three base elements along with the special self-levelling or fixed head, enables uptec to reach any height regardless of the sloped surface (5%), providing exceptional versatility.

uptec



Stackable modular rings designed to meet **any installation height** (from 2 1/4" - 58 mm).



**1 SUPAR**  
+ 1 3/16"  
(+ 30 mm)

# SELF-LEVELLING AND FIXED HEAD

The uptec system incorporates an innovative solution that allows a quick and accurate transition from a self-levelling to a fixed head position with a simple turn of the integrated center ring.

uptec

## SELF-LEVELLING



5% SLOPE

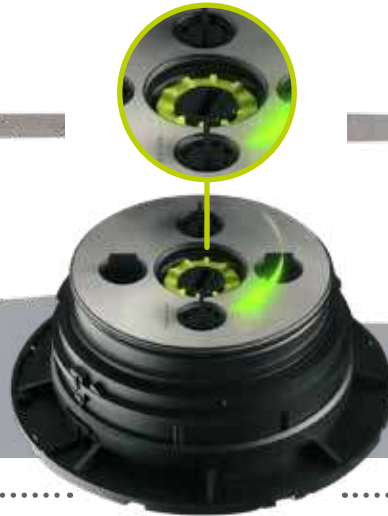

## FIXED



0% SLOPE

## SUPAK MULTIFUNCTION KEY

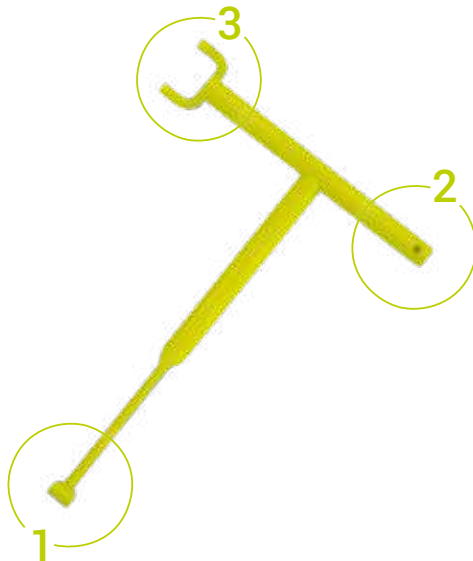

1 Height adjustment

2 Tab removal

3 Self-levelling to fixed head



# FEATURES AND FUNCTIONS

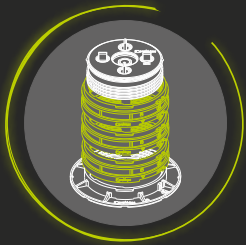

## Modularity

Add SUPAR ring to increase the height of the pedestal

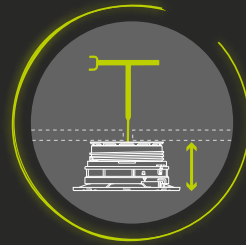

## Adjustable height

Height adjustment is achieved on the surface of the pedestal using the SUPAK key even when all tiles are installed

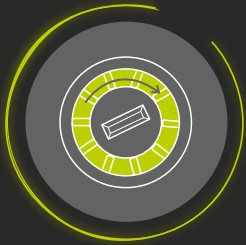

## Self-levelling and fixed head

Simple integrated mechanism to transition from self-levelling to fixed head

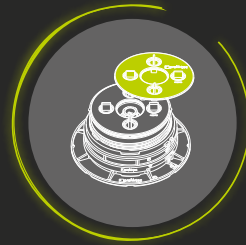

## Interchangeable heads

Interchangeable heads for standard, wood or aluminum joist installations



## Anti-slip and anti-noise

Heads are equipped with anti-slip and anti-noise rubber to reduce impact sound

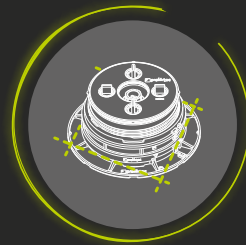

## Pre-cut base

Markings on the base allow corner and perimeter placement



## Low environmental impact

Made completely from recycled and recyclable material



## Load resistance

Resistance to loads up to 3086 lb (1400 kg)

# FIXED HEAD PEDESTALS

uptec FX



uptec<sup>®</sup> FX

Uptec FX consist of fixed head supports that are adjustable in height for the realization of raised floors. Based on the **3-in-1** concept, uptec FX includes 3 base items that minimize inventory levels. The uptec FX system can be assembled to any height of a structure's surface.

The ideal solution in terms of ease of use in the case of large, horizontal and planar surfaces.



# FX

uptec FX



uptec<sup>®</sup> FX

# SUPALFX

Low pedestal

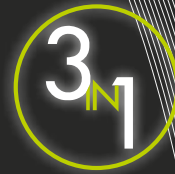

# SUPASFX

Standard pedestal

# SUPAR

Modular ring

combinable with

SUPA2FX

SUPA4FX

SUPAWFX



Head with 3/32"  
(2 mm) tabs



Head with 3/16"  
(4 mm) tabs



Head for wooden  
joists

# COMPOSITION

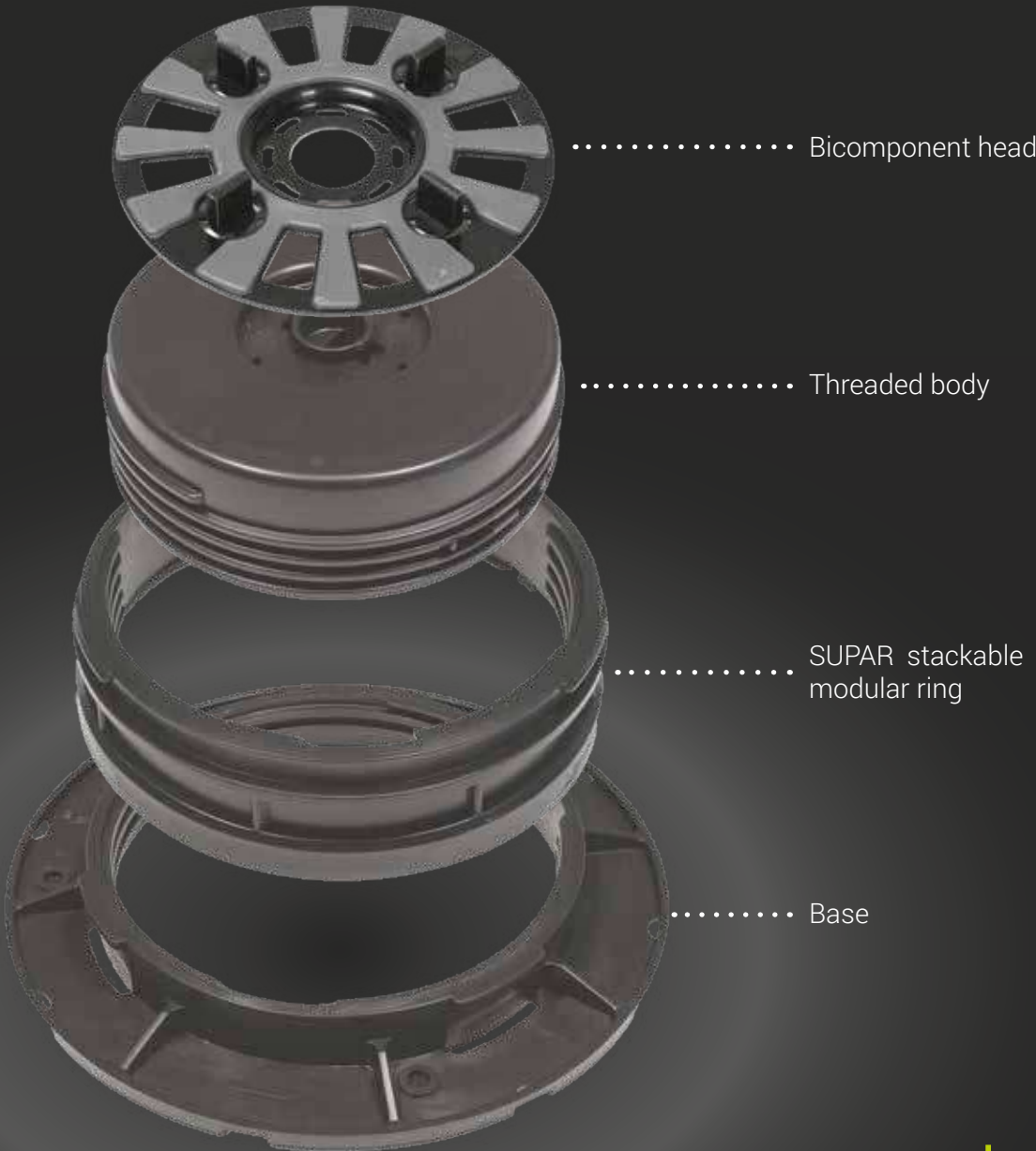

uptec FX

# HEIGHT PROGRESSION

The combination of the three base elements enables uptec to reach any height providing exceptional versatility.

uptec FX



## SUPAK MULTIFUNCTION KEY

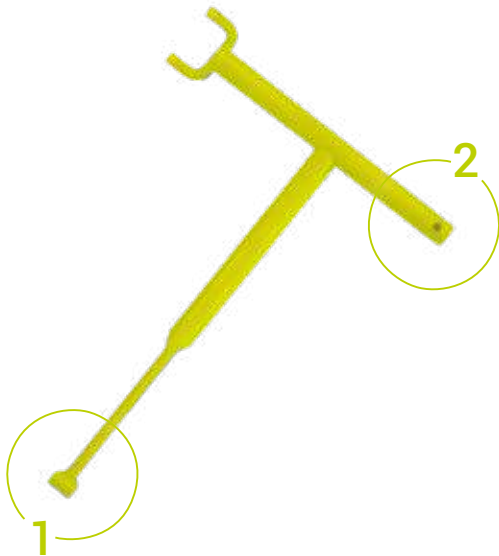

**1** Height adjustment

**2** Tab removal



# FEATURES AND FUNCTIONS

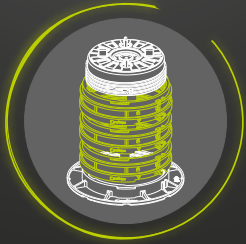

## Modularity

Add SUPAR ring to increase the height of the pedestal

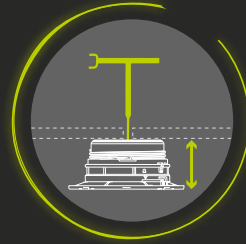

## Adjustable height

Height adjustment is achieved on the surface of the pedestal using the SUPAK key even when all tiles are installed

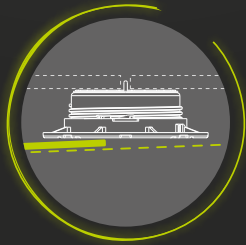

## Slope compensation

Dedicated accessory for slope correction when needed

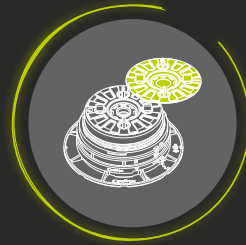

## Interchangeable heads

Interchangeable heads for standard or aluminum joist installations



## Anti-slip and anti-noise

Heads are equipped with anti-slip and anti-noise rubber to reduce impact sound

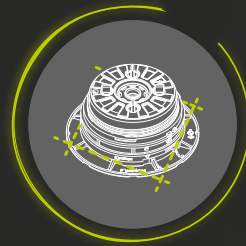

## Pre-cut base

Markings on the base allow corner and perimeter placement



## Low environmental impact

Made completely from recycled and recyclable material

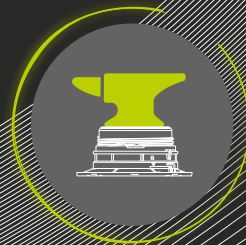

## Load resistance

Resistance to loads up to 3086 lb (1400 kg)

uptec FX

Uptec ground is a support system allowing the installation of raised floors that have minimal height for outdoor use. Two adjustable supports ranging in height from 3/8" (10 mm) to 9/16" (15 mm), SUPT (3/32" - 2 mm joint) or SUPT4 (3/16" - 4 mm joint). Height can be increased by 3/16" (5 mm) using the SUPB stackable accessory (up to a maximum of 3 units).

The system is manually adjustable and does not require the use of an adjustment key.



## SUPT/ SUPT4

Adjustable pedestal  
from 3/8" to 9/16"  
(from 10 mm to 15 mm)



## SUPB

Extension + 3/16" (+5 mm)

# HEIGHT PROGRESSION



uptec ground

# FEATURES AND FUNCTIONS

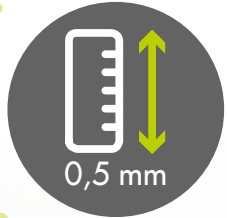

Height can be adjusted by 1/32" (0.5 mm) at the time



Desired height is clearly visible in inches and mm



Made completely from recycled and recyclable material

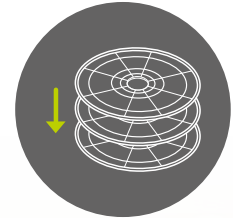

Stackable height extensions

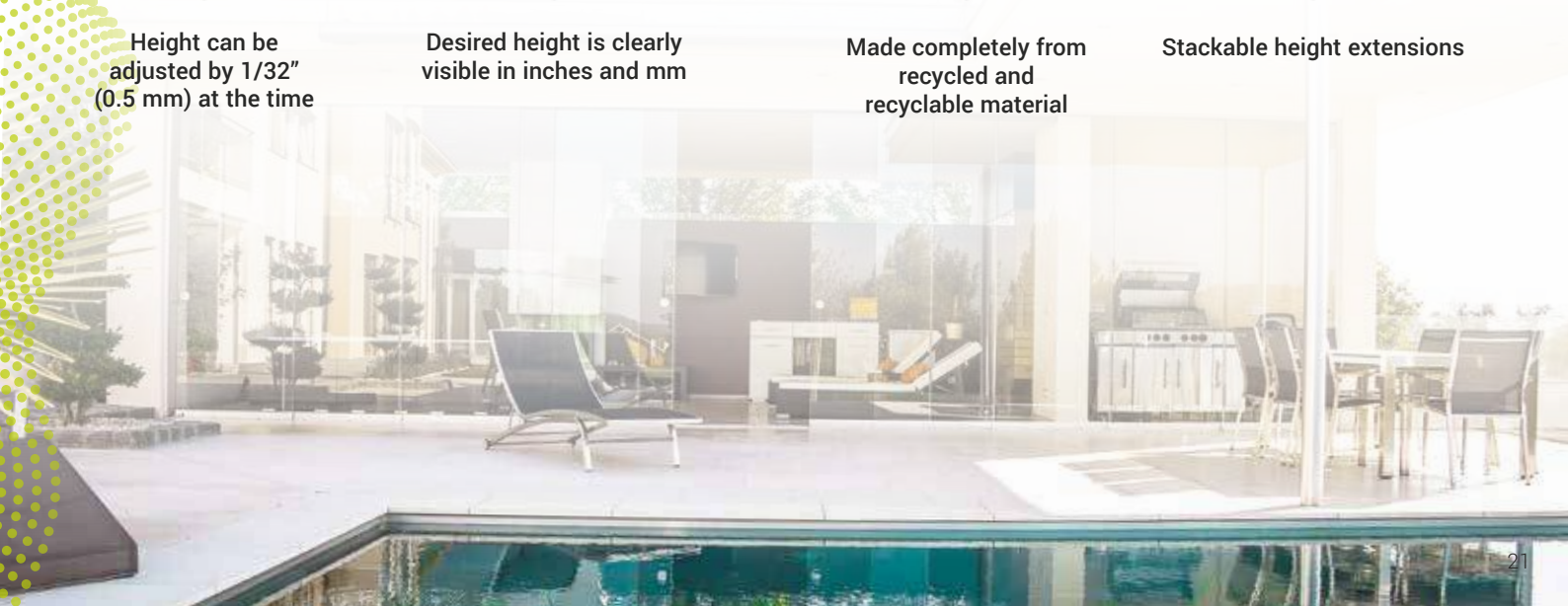

# SUPAWT



## The UPTEC pedestal head for wood tile installations

SUPAWT is a high-performance polypropylene head designed to be mounted on Uptec pedestals, for wood tiles installation. Its 3/16" - 5 mm integrated tabs guarantee perfectly even joints, while dedicated pins lock wood tiles securely in place, ensuring fast installation, precise positioning, and long-term structural stability.

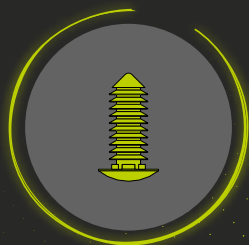

Integrated pins for a strong, secure connection of wood tiles.



Compatible with SUPAK key for easy pedestal height adjustment.

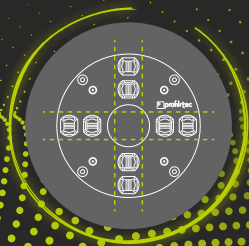

Cutable into halves or quarters for perimeter and corner applications.



Weather-resistant, durable polypropylene material.

# SUPAWTG

## Minimum-height support for wood tile installations

SUPAWTG is polypropylene support designed for wood tiles installations where minimal elevation is required. It features 3/16" - 5 mm integrated tabs to ensure perfectly even joints, along with dedicated fixing pins that securely connect wood tiles, delivering fast installation, accurate alignment, and a stable surface.



Integrated pins for secure fixing of wood tiles.

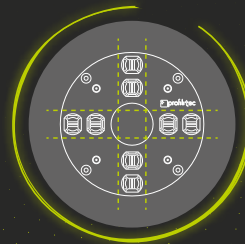

Cuttable into sections for perimeter and corner installations.

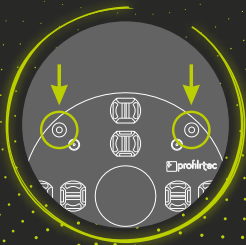

Built-in openings for quick fastening to the substrate.

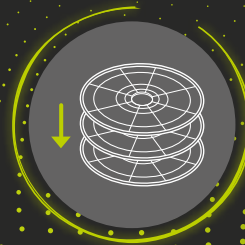

Stackable extensions to reach greater heights.

# THE MODULARITY OF UPTEC AND UPTEC FX

## ADVANTAGES AT THE CONSTRUCTION SITE



### Minimized returns

Any leftover items are easily used in future installations.

### Installation delays reduced

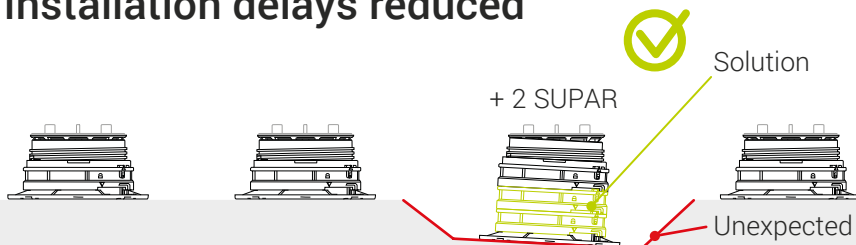

Challenges due to unexpected ground configurations can be quickly resolved eliminating lost time and productivity. Back-and-forth between construction site and warehouse are avoided in case of unexpected complications.



# ADVANTAGES IN THE WAREHOUSE



## Optimized stock management

Minimal number of SKUs permits:

- Extremely simplified management of the entire supply chain.
- Minimized returns from the construction site.

**Profilitec**



**Other solutions**



## Minimum inventory volume and value



**Profilitec**

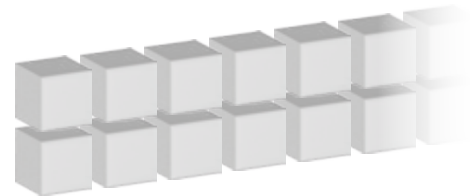

**Other solutions**

# PRODUCT ENGINEERING

Profilltec applies state of the art engineering calculation methods to ensure the highest quality and performance standards.

FEM (Finite Element Method) is a numerical technique that is used in load bearing analysis to evaluate the behavior of a product or structure under stress.

Applying the expected loads, the FEM calculates the stresses, deformations, and structural reaction. The results obtained provide an assessment of the stability and thus the safety of the structure, enabling optimization of the design and prevention of possible failure or collapse.

## Load distribution



FEM calculation which simulate applied loads to the uptec head reveals that load stress on the threaded body develops vertically throughout the support. This **stress** is **concentrated within the circumference of the threaded body** and is not distributed to the base, which means that because of the larger diameter, uptec has ideal load distribution assuring **high weight resistance**.

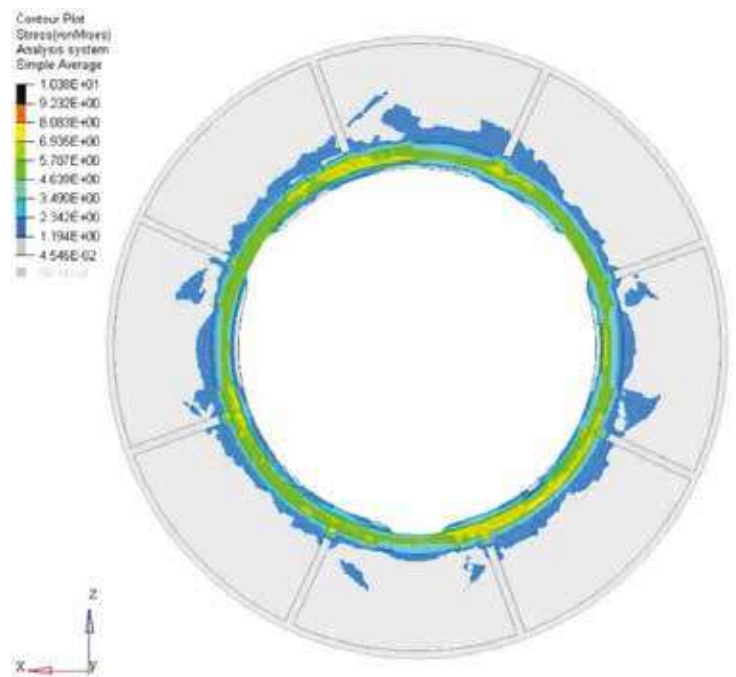
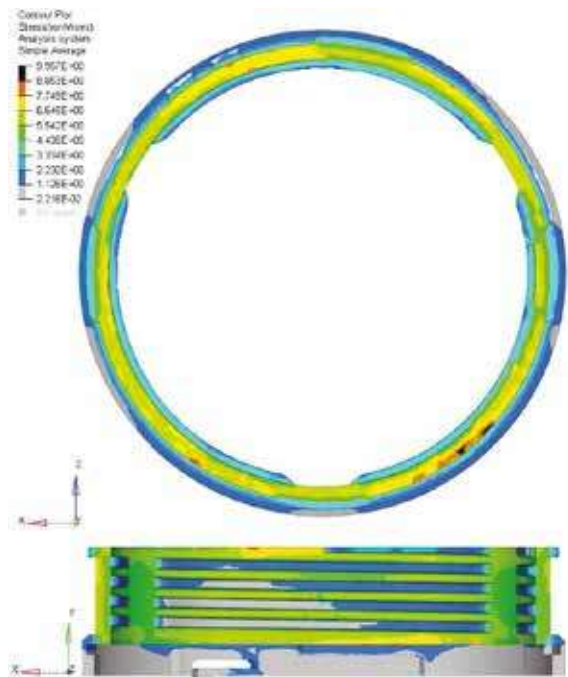

# RECORD-BREAKING STRENGTH, STABILITY AND SAFETY

Uptec has exceptional load resistance of 3086 lb - 1400 kg, moreover the large surface head and the diameter of the threaded body offers greater stability to the tile when placed and a perfect load distribution. These features guarantee outstanding safety and stability performance.

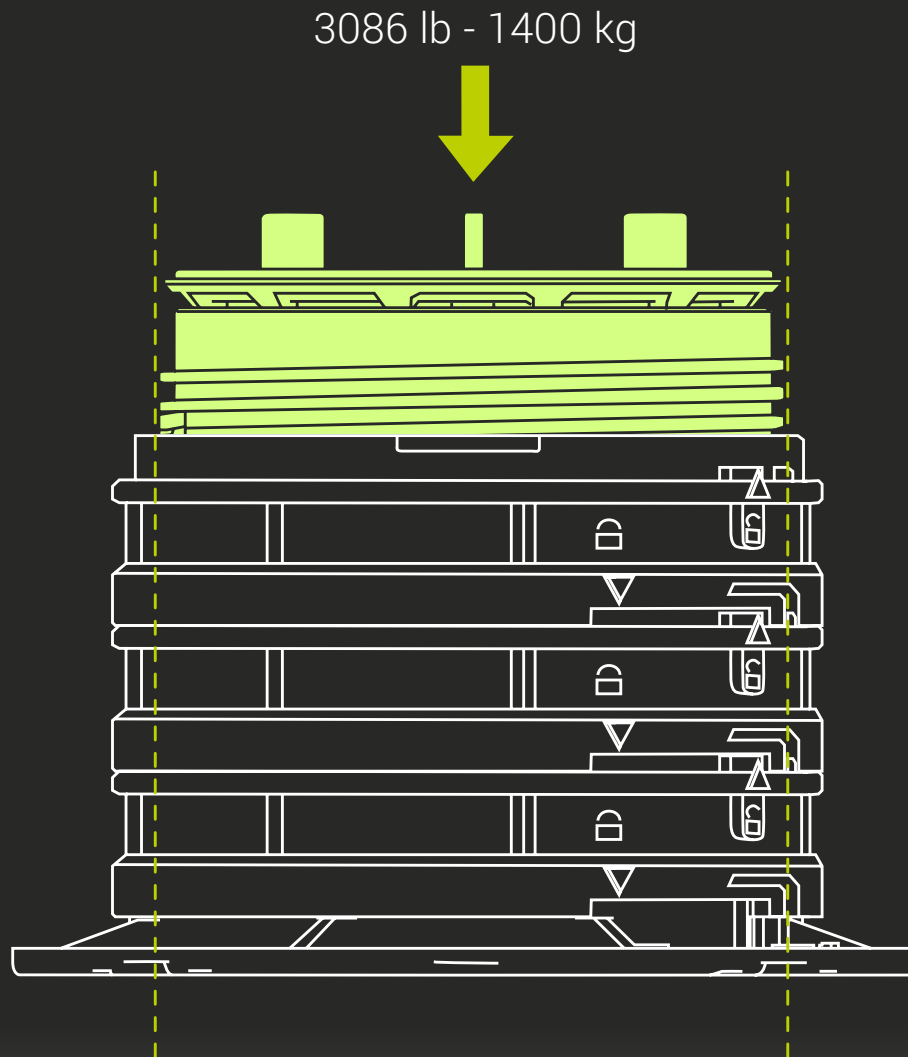

# ACCESSORIES

## SUPACLPB

Clip for perimeter - Base  
to hold 3/4" (2 cm) tiles



## SUPACLPT

Clip for perimeter - Head  
to hold 3/4" (2 cm) tiles



## SUPACLPP

Perimeter tile spacer  
to hold tiles



## SUPL2 - SUPL3

Leveling disk  
3/32" (2 mm) and 1/8" (3 mm) and  
uptec FX slope compensation



## SUPAR120

Modular ring  
of 4-3/4" (120 mm)  
height



## SUPATG

Mat for substrate  
protection



Accessories available for both uptec and uptec FX

# PERIMETER BORDERS

Profilitec offers a wide range of high-quality border profiles, raised floors with uptec and uptec FX systems can be vertically finished with a choice of 3 perimeter profiles that fully meet architectural requirements of installation heights, configurations and colors.

## BSJ

Profile with decorative visible surface of 3/4" (2 cm)



## BSR

Perimeter profile for 3/4" (2 cm) tiles



## BST

Profile with minimal top-visible edge



### Standard finishes:



### Finishes on demand:

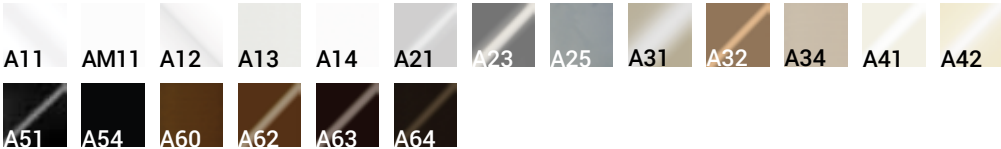

Perimeter border available for both uptec and uptec FX



# SAFETY SYSTEM ZEROFLEX

The SUPATRAY ZeroFlex grid redefines raised outdoor flooring, offering a solid modular substructure free from design constraints. Made from high-quality polypropylene and measuring 23-1/2" x 23-1/2" - 598 x 598 mm, it connects precisely using dedicated locking discs to create a solid, stable, and perfectly integrated surface.

Its structural rigidity and minimal flex ensure absolute stability and safety over time, even under the most extreme conditions of use. SUPATRAY ZeroFlex allows complete freedom in interpreting outdoor space, using tiles of any size and configuration without the need for additional central pedestals.

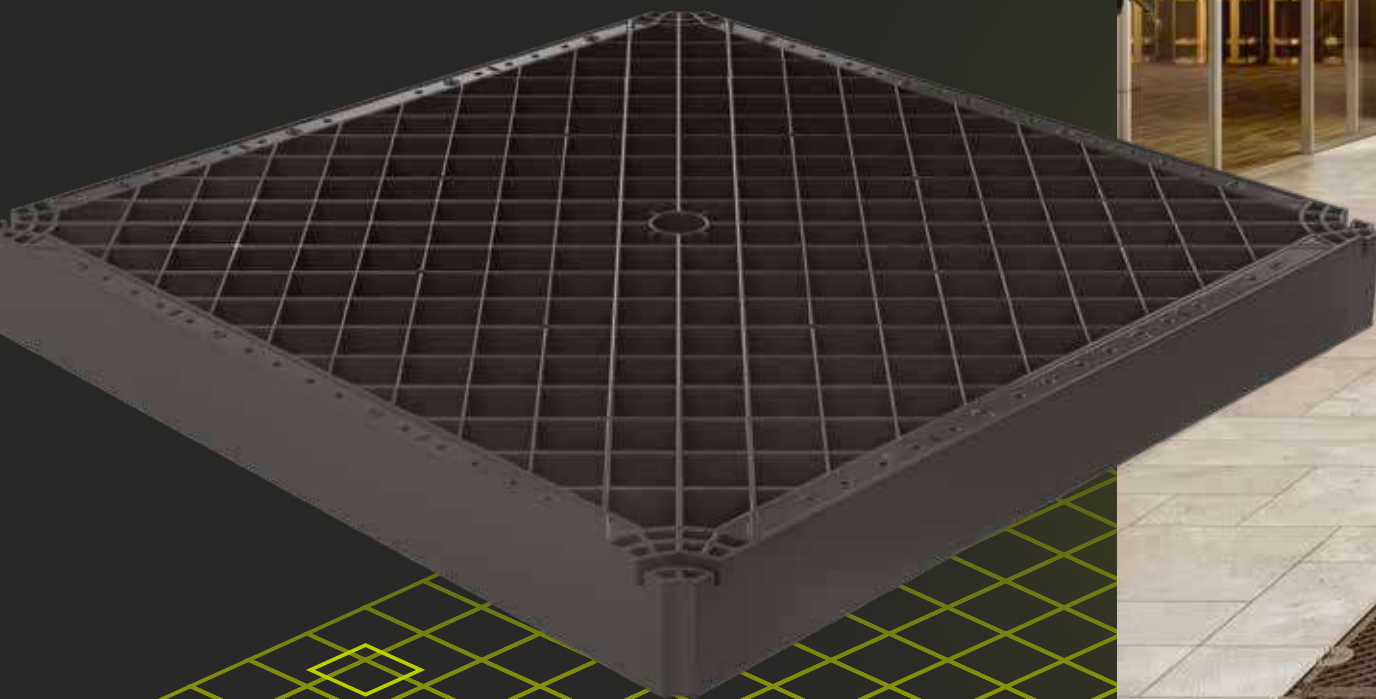



up+tec® up+tec® FX

# FEATURES AND FUNCTIONS



## High load resistance

It can withstand extremely heavy loads, ensuring solid, stable, and safe flooring even in the busiest areas.



## Zeroflex

The structure ensures minimal flex and deformation, guaranteeing extremely stable walking conditions with any tile format.

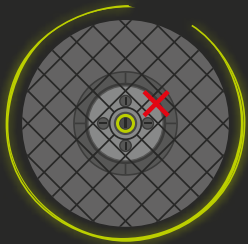

## No central pedestal required

The high structural strength eliminates the need for additional reinforcement pedestals, simplifying installation and reducing costs and installation times.



## Maximum security

Protects against injuries in the event of tile breakage.



TILE .....



SUPATRAYGRIP .....

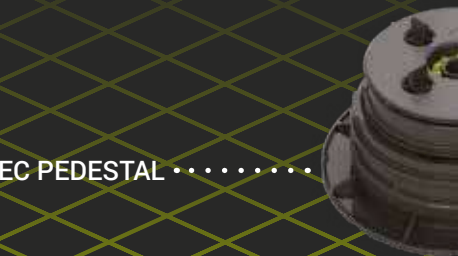
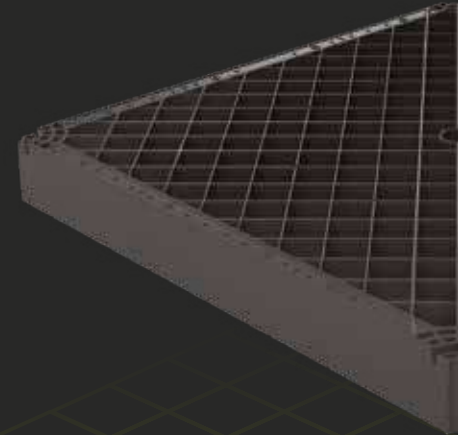

UPTEC PEDESTAL .....



..... SUPATRAYTAB

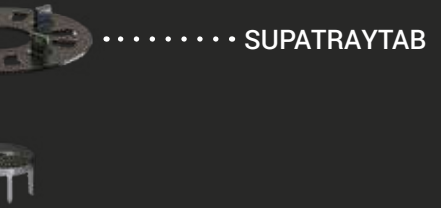

..... SUPATRAYZF

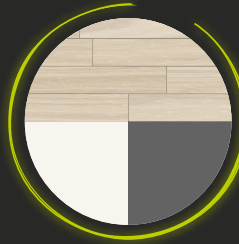
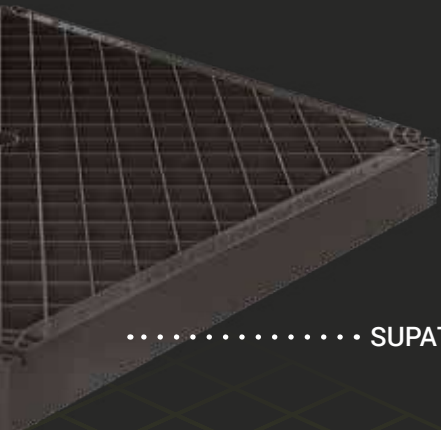

### Maximum design freedom

It allows for the installation of tiles of any size or the combination of different types of coverings, for a completely customizable design without limits.



### Quick and intuitive installation

It guarantees fast, accurate, and smooth assembly, optimizing the installation phases.



### Easy maintenance

Removable and can be inspected at any time, allowing immediate access to the surface below for quick and clean repairs.



### Sustainable and durable

Made from recycled polypropylene and 100% recyclable, resistant to atmospheric agents and wear, it combines high performance with respect for the environment.

# ARTIFICIAL TURF INSTALLATION SYSTEM

The combination of the ZeroFlex grid and the SUPATURF panel creates surfaces that are draining, stable, and perfectly flat, making it ideal for terraces, rooftops, and hanging gardens.

Designed specifically for the application of synthetic turf, this system merges technology, comfort, and aesthetic value. It offers the pleasure of a green turf with the performance of a solid structural solution, transforming any environment into a balance between design and nature.

The SUPATURF panel guarantees a smooth and comfortable walking surface. It includes dedicated openings to ensure rapid and effective water outflow. For easy and secure installation, each panel is supplied with dedicated screws for fastening to the ZeroFlex grid, ensuring both structural strength and long-lasting durability.

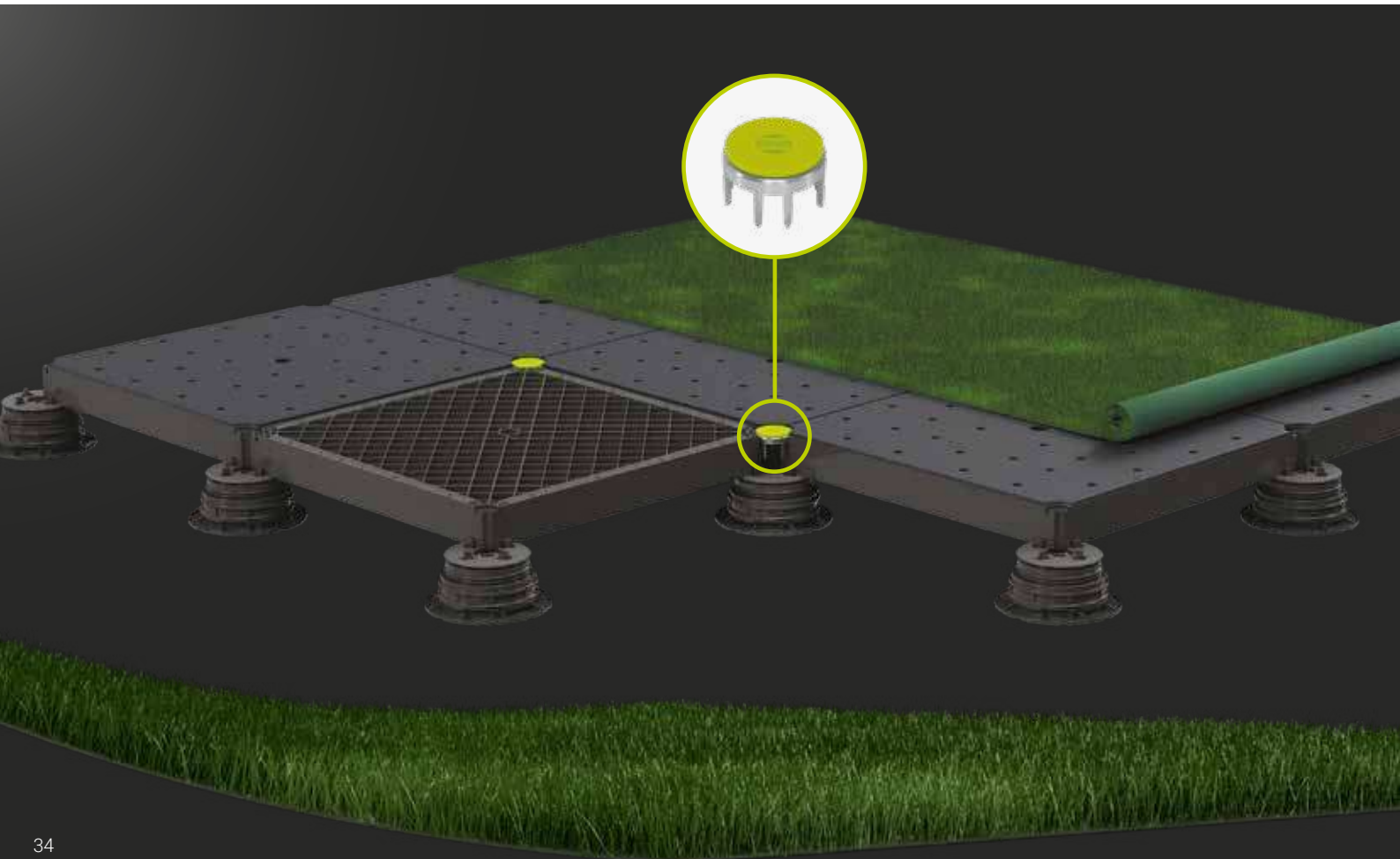

# COMPOSITION

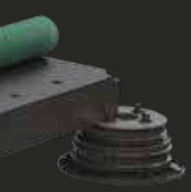
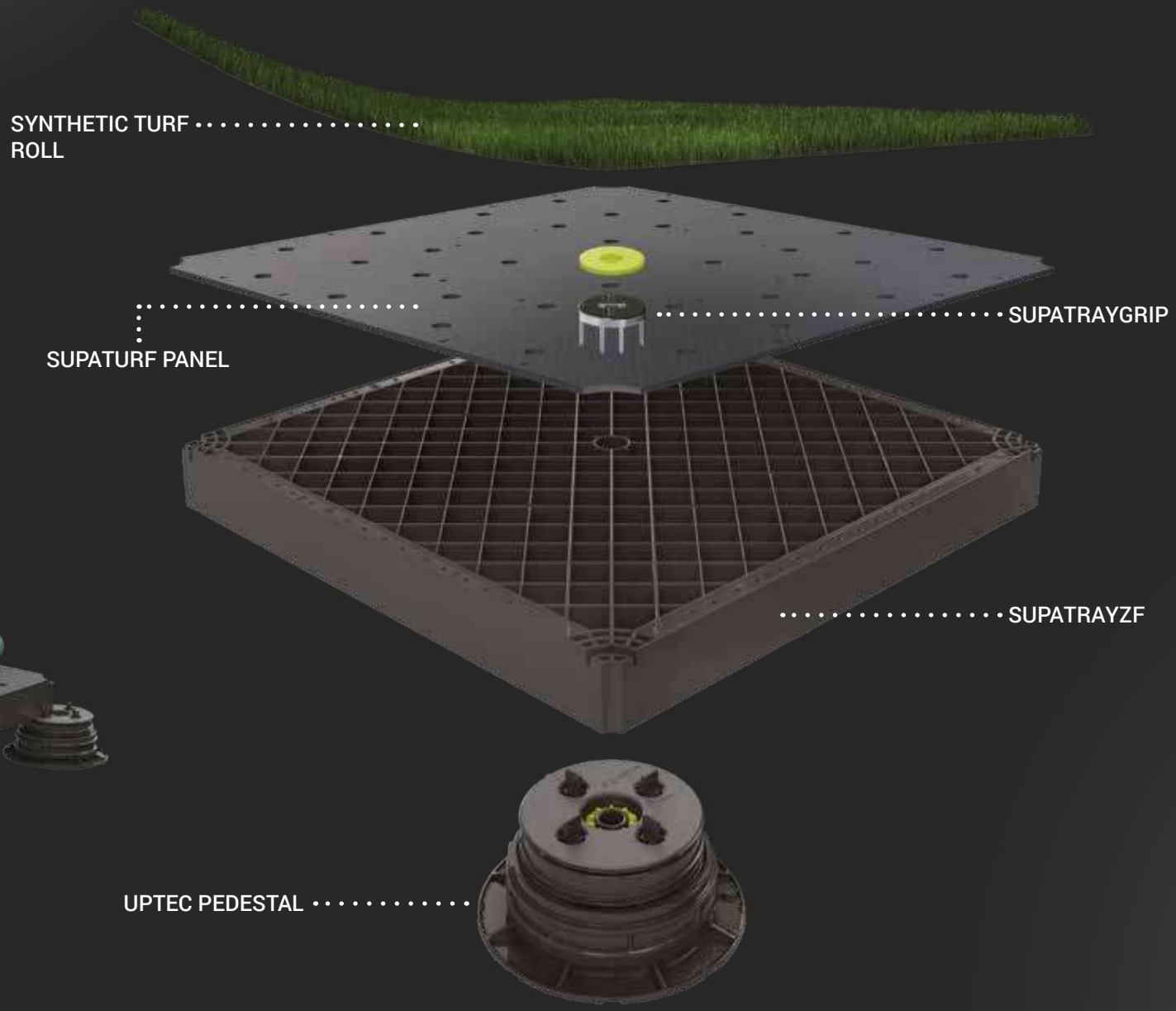

# SUPATRAY SAFETY SYSTEM

The safety grid SUPATRAY is meticulously engineered to provide a versatile and durable raised floor solution to protect against injuries in the event of tile breakage. Featuring a honeycomb structure and dimensions of 23-1/2" x 23-1/2" x 1-1/2" - 598 x 598 x 38 mm, it creates a substructure for any raised floor project. Manufactured with recycled ABS plastic material, it is designed to withstand the test of time and the most challenging weather conditions, offering exceptional durability and impressive load-bearing resistance.

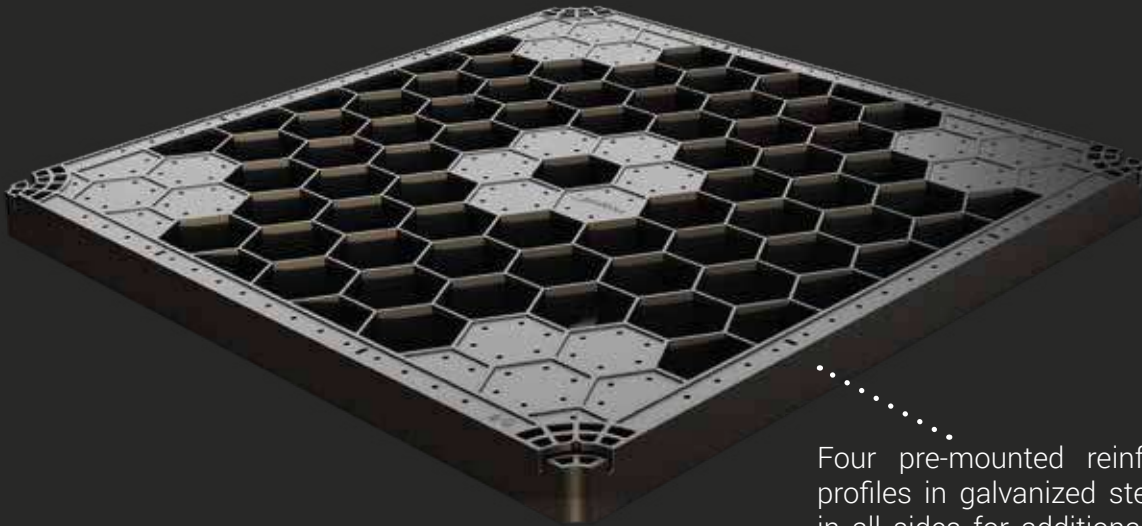

Four pre-mounted reinforcement profiles in galvanized steel placed in all sides for additional strength and stability.



# FEATURES AND FUNCTIONS



## Ultimate Safety

Unmatched protection against injuries in the event of tile breakage, providing peace of mind.

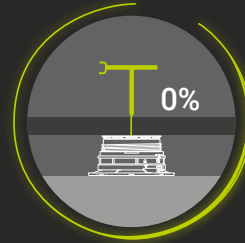

## Perfection in Precision

Achieves perfectly level flooring surfaces and offers the possibility for pedestal height adjustment using the SUPAK multifunctional key for absolute precision.

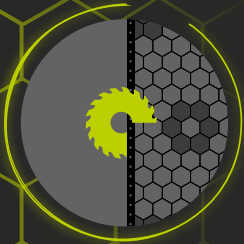

## Tailored Adaptability

Can be easily cut to offer individual customization options for curves, recesses, and small edge sections.

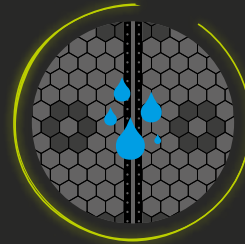

## Efficient Drainage

Guarantees drainage efficiency, ensuring rapid water dispersal through joints and its cavities.

# ACCESSORIES

## SUPATRAYGRIP Locking Disc



## SUPATRAYTAB for 3/32" - 2 mm and 3/16" - 4 mm joints

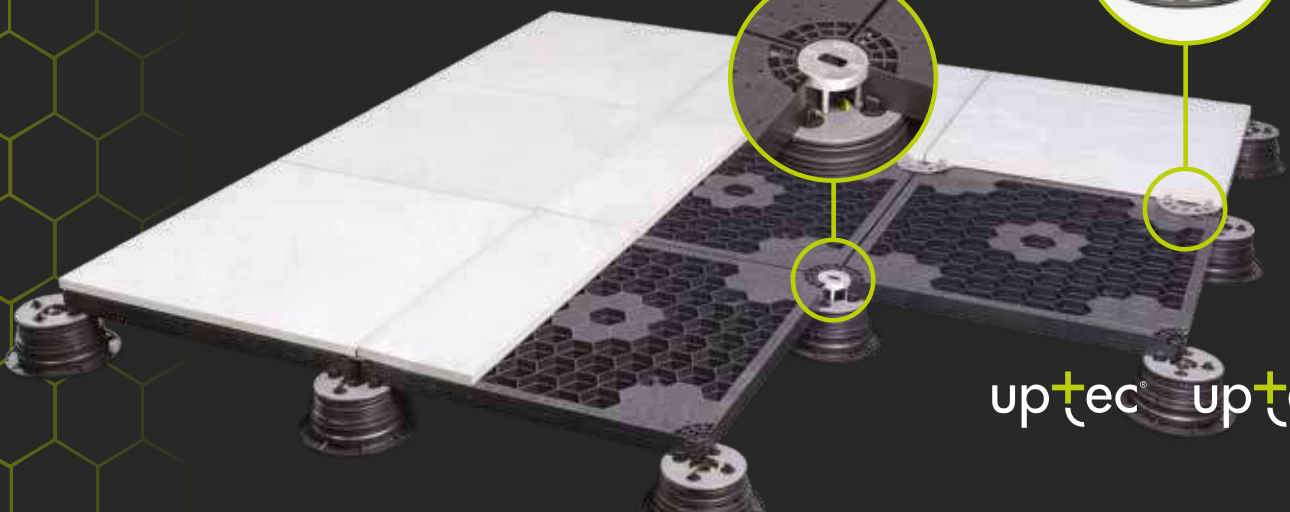
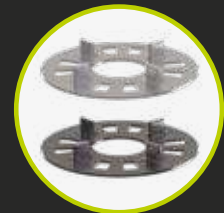

up+tec® up+tec® FX

# WIND UPLIFT SYSTEM

The UPTEC wind uplift system is engineered to withstand strong wind forces and ensure the stability of raised floors in extreme weather conditions, making it the ideal choice for projects in high-wind zones.

The UPTEC wind uplift system includes a safety grid SUPATRAY featuring three adhesive tracks (perimeter, center, and auxiliary sections), Profilitec adhesive FIXXTEC and the locking disc SUPALOCK.

The assembly process is straightforward. Starting with bonding the porcelain pavers onto the SUPATRAY using FIXXTEC adhesive applied to the tracks. Next, the pedestals are positioned and leveled prior to placing the assembled SUPATRAY atop them. To ensure a level and secure surface, all four corners of the trays are firmly connected using the SUPALOCK disc, subsequently locked-in by using the SUPAK key.

## FEATURES AND FUNCTIONS



### Invisible

Featuring a hidden lock down system which allows the surface to maintain its original flush aesthetic.



### Removable

The system allows for easy inspection of the underlying surface, facilitating maintenance and replacement of tiles if needed.



### Fast and safe

Assembly is a straightforward process, eliminating the need to kerf the pavers' sides, preserving their integrity and saving precious time during installation.



### Dual function

SUPATRAY acts as wind uplift system and guarantees safety in case of tile breakage.

# COMPOSITION

LOCKING DISC .....



..... TILE

SAFETY GRID .....



..... ADHESIVE

UPTEC PEDESTAL .....



# WIND UPLIFT TESTING

The UPTEC wind uplift system has undergone rigorous testing at a large-scale facility in the United States. The testing process involves powerful fans generating hurricane-force winds, while the testing specimen is placed on a turntable that rotates to simulate varying wind directions.

This comprehensive testing approach replicates real-world conditions, ensuring an accurate evaluation of the system's performance. **The UPTEC wind uplift system demonstrated its strength by withstanding wind speeds up to Category 4** on the Saffir-Simpson scale (130-156 mph - 210-249 km/h), confirming its exceptional durability and safety for projects in high-wind zones.

## Saffir-Simpson scale





225 km/h

WIND RESISTANCE



## SUPALOCK locking disc

The SUPALOCK aluminum locking disc offers a seamless and secure solution for connecting SUPATRAYS in raised floor systems installed over Uptec pedestals. Engineered from high-quality aluminum, it is built to withstand extreme wind conditions up to 225 km/h. The integrated pins securely fit into the openings on the locking disc, further enhancing its strength and stability.



## FIXXTEC adhesive

FIXXTEC is a multi-purpose adhesive formulated to bond and seal various construction materials. When applied to the adhesive tracks on SUPATRAY, FIXXTEC creates a strong bond between the pavers and trays, ensuring enhanced wind uplift resistance.



## Aluminum profile **SUPAA24240**

SUPAA24240 powder-coated aluminum profile is to be installed along the walls and parapet of the raised floor to further increase its uplift resistance. These robust L-shaped profiles hold the pavers firmly in place and enhance the overall aesthetic harmony of the installation.



# PERFORATED JOIST WITH INTEGRATED RUBBER INSERT

SUPAANG240 is a patented aluminum joist for raised floors that offers freedom and flexibility in the choice of materials, size, and flooring installation pattern.

## Anti-slip and anti-noise rubber

The top portion has two special rails where anti-slip and anti-noise rubber gaskets are inserted. The joist incorporates pre-applied rubber saving installers valuable time and ensuring a quick and easy installation.

## Punched openings

The lower part includes openings that ensure perfect water outflow and allow for height adjustment during and after installation. Additionally, the dented geometry of the openings enables a secure and stable attachment to the head of the pedestal.



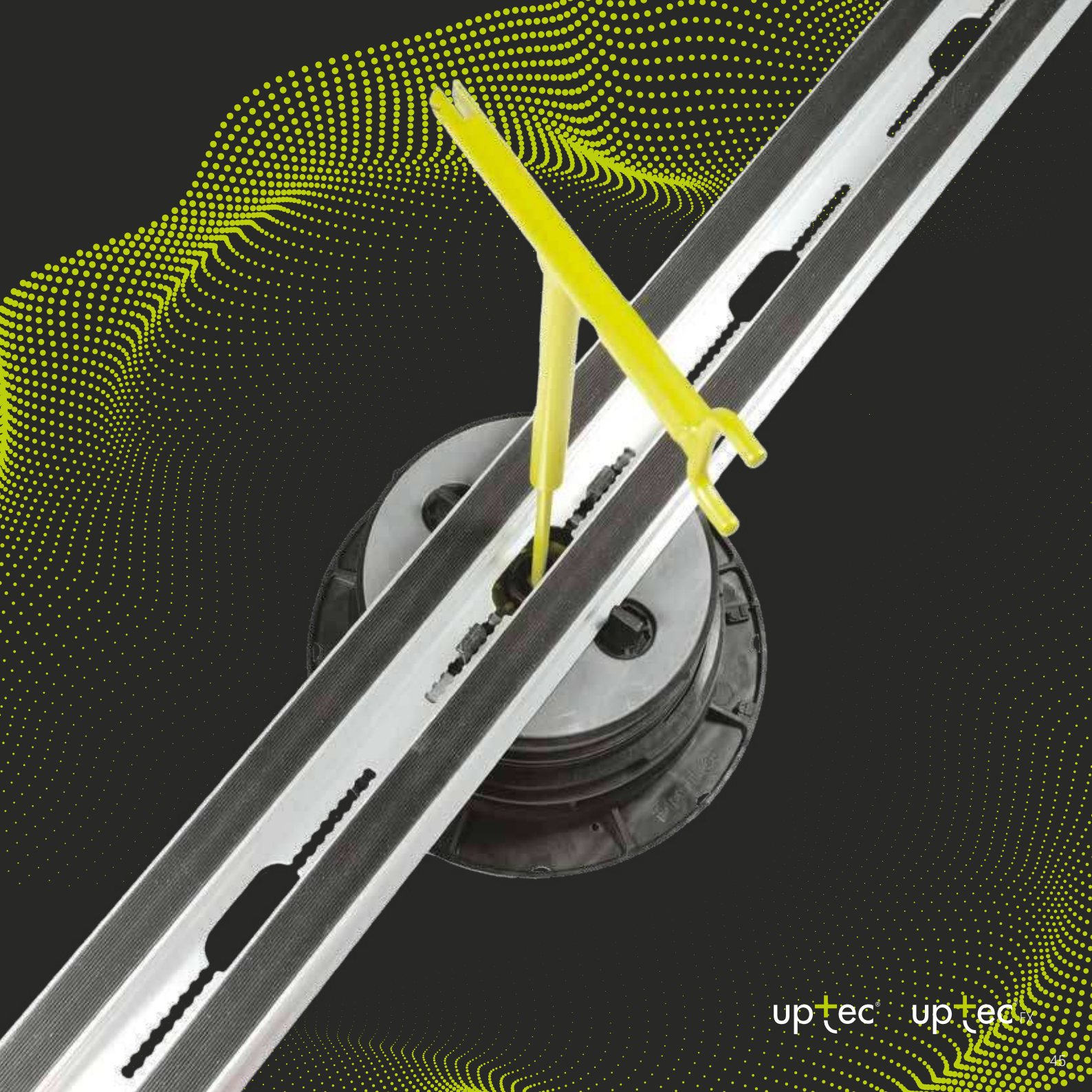

up+tec® up+tec®

# FEATURES AND FUNCTIONS



SUPAANG240 provides maximum freedom and flexibility of tile sizes that can be installed, permits a variety of layout options and various covering materials



SUPAANG240 ensures maximum performance for a structurally stable, safe and quick installation

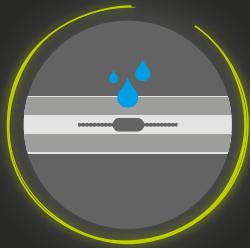

Openings on the base ensure proper water outflow

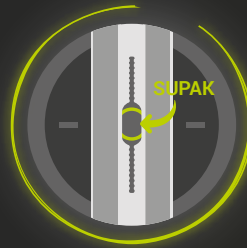

Openings on the base allow height adjustment with the SUPAK key during and after installation

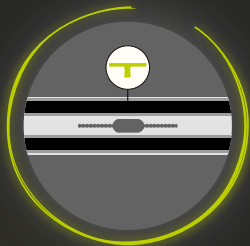

SUPAANG240 comes with the anti-noise integrated rubber inserts

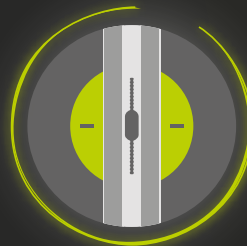

Openings on the base ensure safe and stable attachment to the pedestal head

# JOIST SYSTEM ACCESSORIES

## SUPDG

Tile spacer  
to be used with SUPAANG240



## SUPCLIPG

Perimeter and central clips  
to be used with decking and in  
combination with SUPAANG240



## SUPAJG

Joist junction



## SUPACLPPT

Perimeter tile spacer  
to hold tiles



Accessories available for both uptec and uptec FX

uptec® uptec®FX

# up+tec<sup>®</sup>

## CALCULATOR

[www.profilitec.com/uptec-configurator](http://www.profilitec.com/uptec-configurator)

**Uptec pedestal calculator is an online program to create your own raised floor and calculate the number of supports required for your project.**

Design your surface area or upload an architectural drawing, choose from an extensive list of tile sizes, select the joint width, and set the desired overall height of the assembly. The Uptec pedestal calculator automatically determines which and how many supports and accessories are required for the project.

It is an easy and intuitive tool that offers a wide range of functions to simplify your work. It also provides additional information such as calculation of tiles to be used and lb (kg) of CO<sub>2</sub> saved per ft (m<sup>2</sup>) of floor area.



## EPD Certification

Uptec is EPD certified. In building assessments, building products are evaluated through environmental product declarations (EPDs) conducted in accordance with ISO 14025 and EN 15804:2012+A2:2019.

The analysis evaluates the life cycle of the Uptec system and measures it in terms of carbon footprint with independent third-party verification of the statement and data, according to ISO 14025:2006. A series of case studies have shown that Uptec has an improvement of more than 70 percent in terms of carbon footprint over traditional methods of exterior floor assembly, such as glued tiles on a lightweight screed.



Discover more



**EPD**  
CERTIFICATION

# SYSTEM COMPONENTS AND ACCESSORIES

Code	Product description	Pieces for packaging
SUPAL	Low pedestal	24
SUPAS	Standard pedestal	24
SUPALFX	Low fixed head pedestal	24
SUPASFX	Standard fixed head pedestal	24
SUPAR	Modular ring of 1 3/16" (30 mm)	24
SUPAR120	Modular ring of 4 3/4" (120 mm)	24
SUPT	Reduced height pedestal with 3/32" (2 mm) tabs	50
SUPT4	Reduced height pedestal with 3/16" (4 mm) tabs	50
SUPAWTG	Support for wood tiles	240
SUPB	Extension for SUPT/SUPT4 pedestals	50



SUPAL



SUPAS



SUPALFX



SUPASFX



SUPAR



SUPT - SUPT4



SUPAWTG



SUPB



SUPAR120

Code	Product description	Pieces for packaging
SUPA2	Head with 3/32" (2 mm) tabs	240
SUPA4	Head with 3/16" (4 mm) tabs	240
SUPAW	Head to be fixed on wooden joists	240
SUPAWT	Head for wood tiles	240
SUPA2FX	Head with 3/32" (2 mm) tabs for low fixed head pedestals	240
SUPA4FX	Head with 3/16" (4 mm) tabs for standard fixed head pedestals	240
SUPAWFX	Head for wooden joist	240



SUPA2



SUPA4



SUPAW



SUPAWT



SUPA2FX



SUPA4FX



SUPAWFX

Code	Product description	Pieces for packaging
SUPATRAY	Safety grid	56
SUPATRAYZF	Safety grid ZeroFlex	64
SUPATURF	Panel for artificial turf	16

Code	Product description	Pieces for packaging
SUPATRAYGRIP2	Locking disc for SUPATRAY (3/32" - 2 mm) (safety system)	240
SUPATRAYGRIP4	Locking disc for SUPATRAY (3/16" - 4 mm) (safety system)	240
SUPALOCK	Locking disc for SUPATRAY (wind uplift system)	240
SUPATRAYTAB2	Spacer 3/32" - 2 mm for SUPATRAY	240
SUPATRAYTAB4	Spacer 3/16" - 4 mm for SUPATRAY	240
SUPAA24240	"L" shaped profile for anti wind uplift system	5

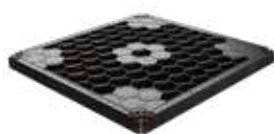

SUPATRAY



SUPATRAYZF



SUPATURF



SUPATRAYGRIP



SUPALOCK



SUPATRAYTAB2



SUPATRAYTAB4



SUPAA24240

Code	Product description	Pieces for packaging
SUPAANG240	Aluminum joist for SUPA4	5
SUPAANGB240	Black aluminum joist for SUPA4	5
SUPDG2	Tile spacer 3/32" - 2 mm	500
SUPDG	Tile spacer 3/16" - 4 mm	500
SUPCLIPG	Perimeter and central clips (Deck)	50
SUPAJGSET20	Joint for joist	20
SUPACLPT	Perimeter clip to hold tiles	5



SUPAANG240 - SUPAANGB240



SUPDG2 - SUPDG



SUPCLIPG



SUPAJG



SUPACLPT

Code	Product description	Pieces for packaging
BSJ	Perimeter profile	10
BSR	Perimeter profile	5/10
BST20	Perimeter profile	5
SUPL2	3/32" (2 mm) leveling disk	600
SUPL3	1/8" (3 mm) leveling disk	500
SUPATG	Mat to protect the substrate	24
SUPACLPBSET5	Perimeter clip - Base	5
SUPACLPTSET5	Perimeter clip - Head	5
SUPACLPPSET5	Perimeter clip	5
SUPAK	Multifunction key	1



**BSJ**



**BSR**



**BST**



**SUPAK**



**SUPL2 - SUPL3**



**SUPATG**



**SUPACLPB**



**SUPACLPT**



**SUPACLPP**



up+tec®





[www.profilitec.com](http://www.profilitec.com)



**Profilitec S.p.A.**

Via Scotte, 3  
36033 Isola Vicentina  
(Vicenza) Italy

[profilitec@profilitec.com](mailto:profilitec@profilitec.com)

+39 0444 268311

**Profilitec Corp.**

472 Meeting Street  
Suite C - #301  
Charleston, SC 29403, USA

[customerservice@profilitec.com](mailto:customerservice@profilitec.com)

+1 855 290 9591

**Profilitec Canada, LTD.**

50 Burnhamthorpe Road West, Suite 900  
L5B3C2 - Mississauga  
(Ontario) CANADA

[customerservice@profilitec.com](mailto:customerservice@profilitec.com)

+1 855 290 9591

**Profilitec Ibérica S.L.**

Camí de Betxí, 2  
12540 Castellón  
Vila-Real, España

[iberica@profilitec.com](mailto:iberica@profilitec.com)

+34 964 18 29 84

**Profilitec France**

26 rue Berjon  
69009 - Lyon  
FRANCE

[france@profilitec.com](mailto:france@profilitec.com)

+33 4 89 47 98 82

BOOKUPT/EN



Rev. 03/26